

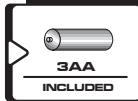

Prolaser® Plus

Model No. 872 GREEN

User Manual

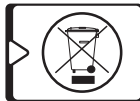
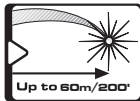
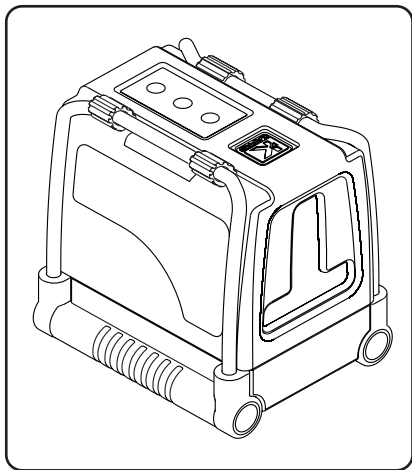

Thank you for purchasing Kapro's 872 GREEN Prolaser® Plus. You now own one of the most advanced laser tools available. This manual will show you how to get the most out of your laser tool.

APPLICATIONS

The 872 GREEN Prolaser® Plus is a laser level with green diodes. This innovatively designed laser can be used for a very broad range of professional and DIY projects, including:

- Aligning tiles, marble, cabinets, borders, moldings and trimmings
- Marking lay out for doors, windows, rails, stairs, fences gates, decks and pergolas installation.
- All types of DIY jobs, including hanging shelves, hanging hooks pictures, curtains and more

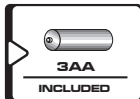
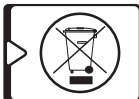
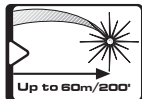

NOTE

Keep this user manual for future reference.

CONTENTS

• Features	4
• Safety instructions	5-6
• Battery installation & Safety	7-8
• Overview	9
• Operating instructions	10-12
• Maintenance	13
• Field calibration test	14-19
• Specifications	20
• Warranty	21



FEATURES

- This laser tool automatically determines the horizontal and vertical plans
- The laser projects intersecting horizontal and vertical lines
- Self-levels in automatic mode when the laser is positioned within its self-leveling range.
- Visual and audible “out of leveling range” warning
- The max. detectable range with detector is 60m (200’).
- Manual mode allows angular layout/markings
- Strong and adjustable metal folding legs allow extreme angle mounting and height adjustment
- Locking mechanism to protect the pendulum during transportation.
- 1/4" tripod adaptor
- Shock resistant rubber casing
- Compact size – fits in your toolbox

NOTE

This device contains precision components that are sensitive to external shock, impact or falls that may compromise its functionality – handle with care to maintain its accuracy.

SAFETY INSTRUCTIONS



WARNING

This product emits radiation that is classified as class II according to EN 60825 -1

Laser radiation can cause serious eye injury



- Do not stare into the laser beam
- Do not position the laser beam so that it unintentionally blinds you or others.
- Do not operate the laser level near children or let children operate the laser level.
- Do not look into a laser beam using magnifying optical devices such as binoculars or a telescope, as this will increase the level of eye injury.



WARNING: This product contains lead in solder and certain electrical components contain chemicals which are known to the State of California to cause cancer, birth defects or other reproductive harm.

(California Health & Safety Code Section 25249.6- Proposition 65)



NOTE

The green goggles are intended to enhance the visibility of the laser beam. They will not protect your eyes against laser radiation.



- Do not remove or deface warning labels on the laser level.
- Do not disassemble the laser level, laser radiation can cause serious eye injury.
- Do not drop the laser.
- Do not use solvents to clean the laser.
- Do not use in temperatures below -10°C or above 45°C (14°F / 113°F)
- Do not operate the laser in explosive environments such as flammable liquids, gases or dust. Sparks from tools can cause ignition.
- When not in use, turn off the power, engage the pendulum lock and place the laser in the carrying pouch.
- Make sure the pendulum lock mechanism is engaged before transporting the laser.

NOTE

If the pendulum lock mechanism is not engaged before transportation, internal mechanical damage can occur.

BATTERY INSTALLATION & SAFETY

1. Press down on the latch and remove the battery cover.
2. Insert 3 new AA batteries of the same brand according to the polarity diagram on the inside of the battery compartment.
3. Reclose the battery cover.

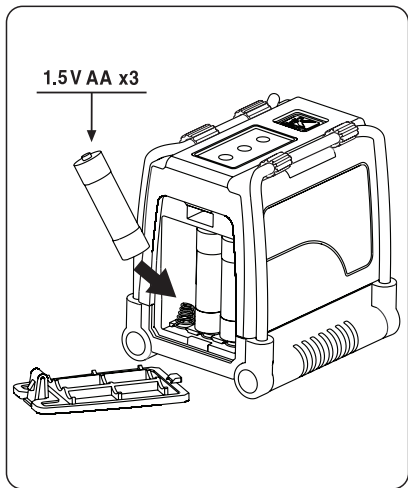

NOTE

If the laser level will not be used for a long period, remove the batteries from the battery compartment. This will prevent batteries from leaking and corrosion damage.

 **WARNING:** Batteries can deteriorate, leak or explode, and can cause injury or fire.

1. Do not shorten the battery terminals.
2. Do not charge Alkaline batteries.
3. Do not mix old and new batteries.
4. Do not dispose of batteries into household waste.
5. Do not dispose batteries in fire.
6. Defective or dead batteries must be disposed according to local Regulations.
7. Keep the batteries out of reach from children.

OVERVIEW

1. On/Off Locking Switch

2. Metal legs

3. Keypad

- a. Manual Mode button
- b. Beam Selector button
- c. Pulse Mode button
- d. Manual Mode LED
- e. Laser beam LED
- f. Pulse mode LED

4. Laser output window

5. Battery cover

6. ¼" tripod mount

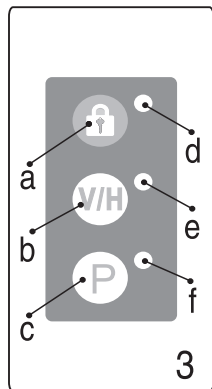
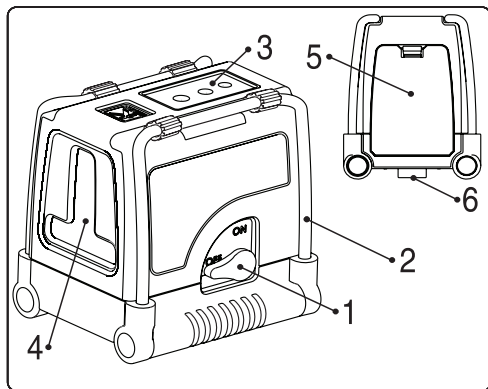



OPERATING INSTRUCTIONS

Working in Automatic mode (self-leveling):



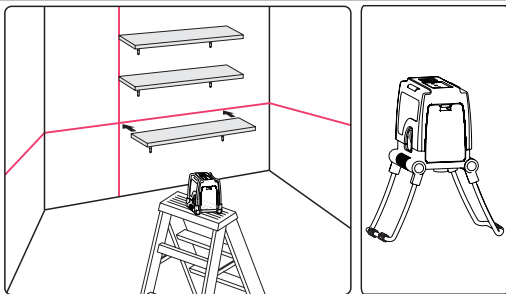

In Automatic mode, the laser will level itself in a $\pm 3^\circ$ range and project horizontal, vertical or both lines simultaneously

1. Remove the laser from the case and place it on a solid, flat, vibration free surface or on a tripod.
2. Turn the locking switch (#1) clockwise to the **ON** position, the laser level will generate the crossed horizontal and vertical lines and the green LED near the **V/H** button will light up.
3. Choose the beams that you want to work with presing the **V/H** beam button.
4. Use the adjustable metal legs (#2) to adjust the height of the horizontal line.
5. If the initial slope of the laser is beyond $\pm 3^\circ$ and the automatic mode is activated the laser lines will flash and a beeping alarm will sound. In this case reposition the laser on a more leveled surface.
6. Before moving the laser level, turn the locking switch (#1) to the **OFF** position, this will lock the pendulum and protect your laser.



Working in Manual mode:

In Manual mode the 872G's self-leveling mechanism is disabled and the laser lines can be set at any slope required. The laser beams will flash every 3 seconds to let you know that you are working outside the self-leveling range and the beams may not be leveled.

1. Press the Manual push button mode . The laser will project the cross lines and the red LED near the push button  will light up. The green LED of the laser beams near **V/H** push button will light up.
2. Choose the beams that you want to work with by pushing the Beam Selector push button **V/H**
3. To mark a slope, tilt the laser using the adjustable folding legs to modify the angle and the height.
4. To turn the manual mode off, press again the Manual push button .
5. While in Manual mode turning the locking switch #1 from **OFF** to **ON** will turn off the Manual mode and the red LED near the  push button. The automatic self – leveling will be activated if the laser level is within the self – leveling range.

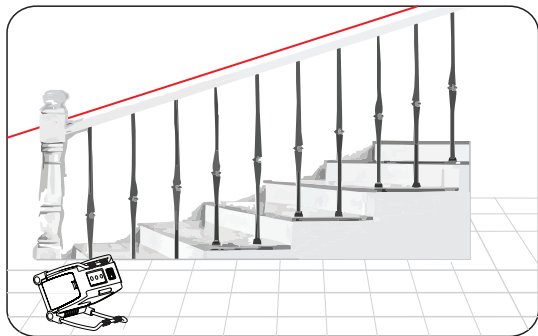

Working in Pulse mode with a detector:

For outdoor work, under direct sunlight, bright conditions or for extended indoor ranges up to 60 meters, use the Pulse mode with a Detector.

When the Pulse mode is activated, the laser lines will flash at very high frequency (invisible to the human eye) allowing the detector to detect the laser lines.

1. The Pulse mode can be activated in Automatic and Manual modes.
2. To switch on the Pulse Mode press the **P** button, the green LED near the **P** push button will light up.
3. When the Pulse mode is switched on, the visibility of the laser lines are reduced a little bit.
4. To switch the Pulse mode off, press the **P** button again, the green LED near the **P** button will turn off.

MAINTENANCE

To maintain the accuracy of your project, check the accuracy of your laser level according to the field calibration tests procedures.

- Change the batteries when the laser beams begins to dim.
- Wipe the aperture lens and the body of the laser level with a clean soft cloth. Do not use solvents.
- Although the laser level is dust and dirt resistant to a certain degree, do not store in dusty places as long term exposure may damage internal moving parts.
- If the laser level is exposed to water, dry the laser level before returning it to the carrying case, to prevent corrosion damage.
- Remove the batteries if the laser level is unused for a long period of time, to prevent corrosion damage.

Repairs

See the warranty section at the end of this manual.

- Do not take the 872G Prolaser apart or permit unqualified persons to disassemble it.
- Repair the measuring tool through qualified technicians using original spare parts.
- Unauthorized service may cause eye injury, irreparably damage the laser level and void the warranty.

This laser level left the factory fully calibrated. Kapro recommends the user check the accuracy of the laser periodically, especially if the unit falls or is mishandled.

1. Check the height accuracy of the horizontal beam.
2. Check the leveling accuracy of the horizontal beam.
3. Check the leveling accuracy of the vertical beam.
4. Check the perpendicularity between the 2 vertical beams.

1. Checking the Height Accuracy of the Horizontal beam. (Up and down deviation)

- 1) Set up the laser on a tripod or on a flat surface between two walls **A** and **B**, approximately 5 meters apart.
- 2) Position the laser level approximately 0.5 meter from wall **A**
- 3) Unlock the pendulum and press the button to project the horizontal and the vertical cross beams towards wall **A**.
- 4) Mark the center of the cross beams on the wall as **a1** (see figure # 1).

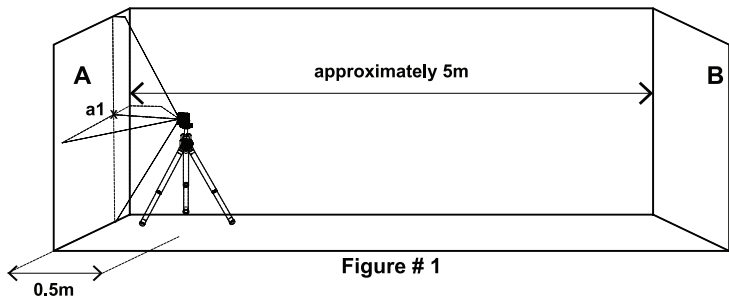

Figure # 1

5) Turn the laser 180° towards wall **B** and mark the center of the cross beams as **b1** on the wall (see figure 2).

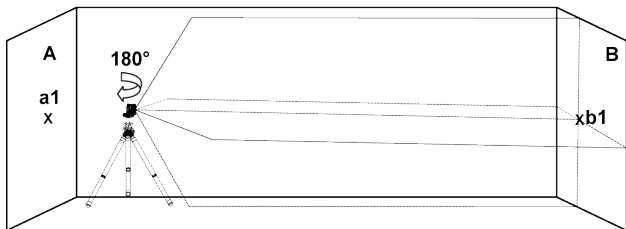

Figure # 2

6) Move the laser level towards wall **B** and position it approximately 0.5 meter from wall **B**.

7) Mark on wall **B** the center of the cross beams as **b2** (see figure 3).

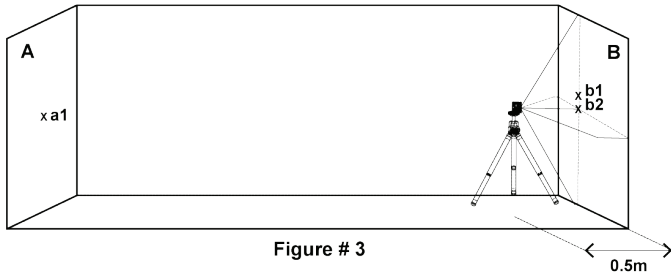

Figure # 3

- 8) Turn the laser 180° towards wall **A**, and mark on the wall the center of the cross lines as **a2** (see figure 4).

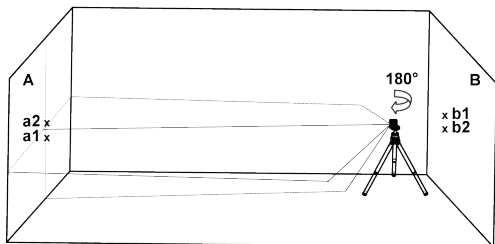

Figure # 4

- 9) Measure the distances:

$$\Delta a = |a2 - a1|$$

$$\Delta b = |b1 - b2|$$

- 10) The difference $|\Delta a - \Delta b|$ should be no more than 2 mm, otherwise send the laser level to a qualified technician for repair.

Checking the Level Accuracy of the Horizontal beam. (Side to side inclination)

- 1) Set up the laser on a tripod or on a flat surface at a distance of approximately 1.5 meters from a 5 meter/16 feet long wall.
- 2) Unlock the pendulum and press the button to project the horizontal and the vertical cross beams towards the wall.

- 3) Mark point **a1** on the wall, in the middle of the horizontal line at the left edge of the horizontal beam (see figure 5).

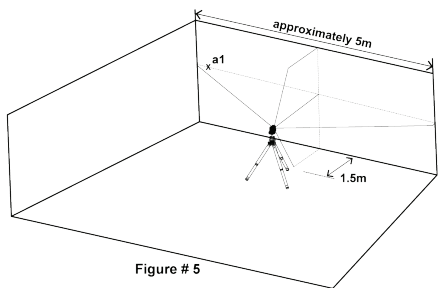

Figure # 5

- 4) Turn the laser level counterclockwise until the right edge of the horizontal line reaches near **a1**, mark a point **a2** on the wall in the middle of the horizontal beam (see figure 6).

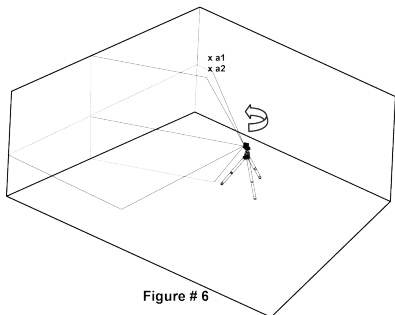
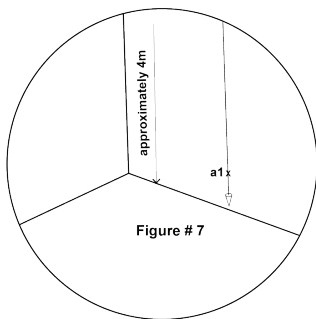

Figure # 6

- 5) The distance between **a1** and **a2**, should be no more than 1 mm, otherwise, send the laser level to a qualified technician for repair.

Checking the Accuracy of the Vertical beam.

- 1) Hang an approximately 4 meter/13 feet plumb line on a wall.
- 2) After the plumb line has settled, mark point **a1** on the wall behind the plumb line, near the plumb cone. (see figure 7).



- 3) Set up the laser on a tripod or on a flat surface in front of the wall at a distance of approximately 2 meters/6.5 feet.
- 4) Unlock the pendulum, and press the button to project the vertical beam toward the plumb line.
- 5) Turn the laser so that the vertical beam will merge with the plumb line below the hanging point.

- 6) Mark point **a2** on the wall, in the middle of the vertical beam at the same height as **a1**. (see figure 8).

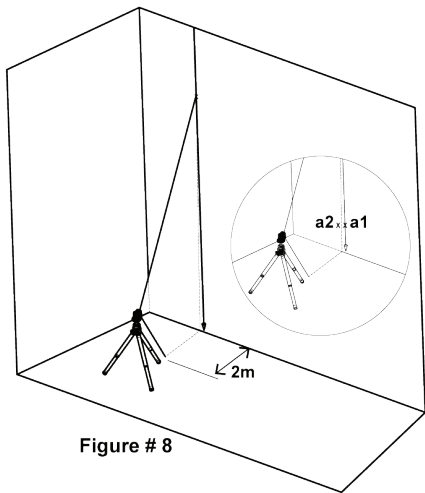

Figure # 8

- 7) The distance between **a1** and **a2**, should be no more than 1mm, otherwise send the laser level to a qualified technician for repair.



SPECIFICATIONS

Laser beams output pattern	Vertical and horizontal cross lines Horizontal line Vertical line
Laser range	<ul style="list-style-type: none">Indoor - 30m (100ft)Outdoor with detector 60m (200ft)
Accuracy	$\pm 0.2\text{mm/m}$ ($\pm 0.0002\text{in/in}$)
Fan angle	$120^\circ \pm 5^\circ$
Self-leveling range	$\pm 3^\circ$
Laser line width	2 mm $\pm 0.5\text{mm}/5\text{m}$ (0.10" ± 0.02 " at 20')
Wavelength	520 $\pm 10\text{nm}$ - Laser Class II
Power supply	3 AA batteries (included)
Battery life	6 hours of continuous operation
Operating temp	-10° C + 45° C (14°F +113°F)
Storage temp	-20° C +60° C (-4°F +140°F)
Water & dust proof	IP54
Dimensions	10cm x 8.2cm x10.4cm (3.9" x 3.2" x 4.1")
Weight including batteries	620gr $\pm 10\text{gr}$ (1.37lbs $\pm 0.35\text{oz}$)

WARRANTY

This product is covered two-year limited warranty against defects in materials and workmanship. The warranty does not cover products that are used improperly, altered or repaired without Kapro Tools' approval. In the event of a problem with the laser level, please return the product to the place of purchase with proof of purchase.

Model #872 GREEN Prolaser® Plus

The serial number sticker is positioned inside the battery compartment.

CE CONFORMITY CERTIFICATE

This product meets the standards of the Electromagnetic Compatibility (EMC) established by the European Directive 2014/30/EU and the Low Voltage Directive (LVD) 2014/35/EU

EC DECLARATION OF CONFORMITY

We declare under our responsibility that the product 872G is in accordance with the requirements of the Community Directives and Regulations:

2014/30/EU

2011/65/EU

EN60825-1: 2014

EN61326-1: 2013