

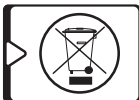

Prolaser[®] Vector

Model No. 873 GREEN

User Manual

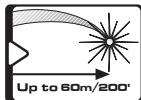
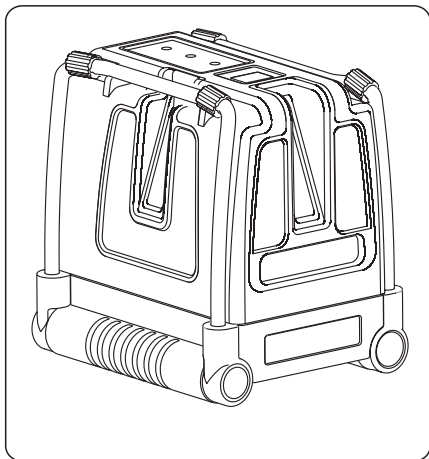

Thank you for purchasing Kapro's 873 GREEN Prolaser® Vector. You now own one of the most advanced laser tools available. This manual will show you how to get the most out of your laser tool.

APPLICATIONS

The 873 GREEN Prolaser® Vector is a laser level with green diodes. The laser is innovatively designed for a very broad range of professional and DIY jobs, including:

- Aligning tiles, marble, cabinets, borders, moldings and trimmings
- Marking layout for doors, windows, rails, stairs, fences, gates, decks and pergolas installation.
- All types of DIY jobs, including hanging shelves, hanging hooks, pictures, curtains and more

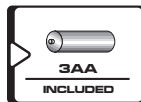
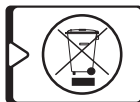
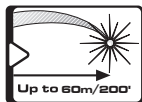

NOTE

Keep this user manual for future reference.

CONTENTS

• Features	4
• Safety instructions	5-6
• Battery installation & Safety	7-8
• Overview	9
• Operating instructions	10-12
• Maintenance	13
• Field calibration test	14-24
• Specifications	25
• Warranty	26



FEATURES

- This Laser tool automatically determines horizontal and vertical plans
- This laser projects 1 horizontal and 2 orthogonal vertical green beams, intersecting forward and on the ceiling.
- Self-levels in automatic mode when the laser is positioned within its self-leveling range.
- Visual and audible “out of leveling range” warning
- Pulse mode emits pulses that can be detected by a laser detector, increasing the products range to up to 60m (200')
- Manual mode allows angular layout/marking
- Strong and adjustable metal folding legs allow extreme angle mounting and height adjustment
- The locking mechanism protects the pendulum during transportation or when the laser is not in use.
- 1/4" tripod adaptor
- Shock resistant rubber casing
- Compact size – fits in your toolbox

NOTE

This device contains precision components that are sensitive to external shock, impact or falls that may compromise its functionality – handle with care to maintain its accuracy.

SAFETY INSTRUCTIONS



WARNING

This product emits radiation that is classified as class II according to EN 60825 -1

Laser radiation can cause serious eye injury



- Do not stare into the laser beam
- Do not position the laser beam so that it unintentionally blinds you or others.
- Do not operate the laser level near children or let children operate the laser level.
- Do not look into a laser beam using magnifying optical devices such as binoculars or a telescope, as this will increase the level of eye injury.



WARNING: This product contains lead in solder and certain electrical components contain chemicals which are known to the State of California to cause cancer, birth defects or other reproductive harm.

(California Health & Safety Code Section 25249.6- Proposition 65)



NOTE

The green goggles are intended to enhance the visibility of the laser beam. They will not protect your eyes against laser radiation.

- Do not remove or deface warning labels on the laser level.
- Do not disassemble the laser level, laser radiation can cause serious eye injury.
- Do not drop the laser.
- Do not use solvents to clean the laser.
- Do not use in temperatures below -10°C or above 45°C (14°F / 113°F)
- Do not operate the laser in explosive surroundings such as flammable liquids, gases or dust. Sparks from tools can cause ignition.
- When not in use, turn off the power, engage the pendulum lock and place the laser in its carrying pouch.
- Make sure the pendulum lock mechanism is engaged before transporting the laser.

NOTE

If the Pendulum lock mechanism is not engaged before transportation, internal mechanical damage may occur.

BATTERY INSTALLATION

1. Press down the latch and remove the battery cover.
2. Insert 3 new AA batteries of the same brand according to the polarity diagram on the inside of the battery compartment.
3. Reclose the battery cover.

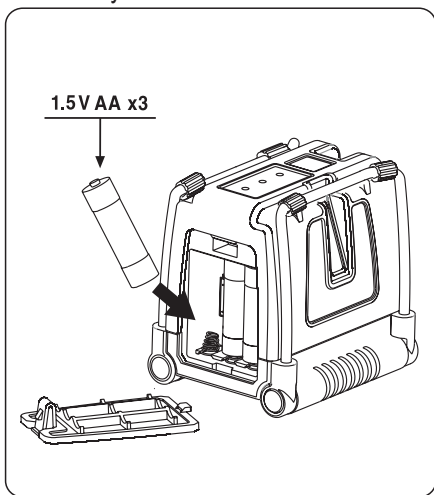

NOTE

If the laser level is not in use for a long period of time, remove the batteries from the battery compartment. This will prevent batteries from leaking and corrosion damage.

 **WARNING:** Batteries can deteriorate, leak, explode, causing injury or fire.

1. Do not shorten the battery terminals.
2. Do not charge Alkaline batteries.
3. Do not mix old and new batteries.
4. Do not dispose of batteries into household waste.
5. Do not dispose of batteries in fire.
6. Defective or dead batteries must be disposed of, according to local regulations.
7. Keep the batteries out of reach of children.

OVERVIEW

1. On/Off Locking Switch

2. Metal legs

3. Stabilizing rubber sleeve

4. Keypad

a. Manual Mode button

b. Beam Selector button

c. Pulse Mode button

d. Manual Mode LED

e. Laser Beam LED

f. Pulse Mode LED

5. Horizontal window

6. Forward vertical window

7. Side vertical window

8. Battery cover

9. ¼" tripod mount

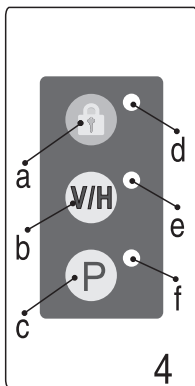
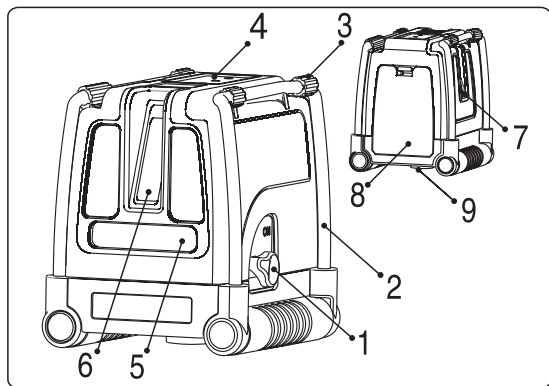



Working in Automatic mode (self-leveling):

In automatic mode the laser level will level itself in a $\pm 3^\circ$ range and can project a horizontal beam, two vertical beams or all 3 beams simultaneously.

1. Remove the laser from the case and place it on a solid flat vibration free surface or on a tripod.
2. Turn the locking switch #1 clockwise to the **ON** position. The laser level will generate horizontal and vertical beams forward and an additional orthogonal side vertical beam. The green LED near the **V/H** button will light up.
3. The laser will generate upwards and forward cross beams when all beams are activated.
4. Choose the beams that you want to work with by pushing the **V/H** beam button
5. Use the adjustable metal legs #2 to adjust the height of the horizontal beam.
6. If the initial level of the laser is beyond $\pm 3^\circ$ and the automatic mode is activated the laser beams will flash and a beeping alarm will be heard. In this case reposition the laser on a more level surface.
7. Before moving the laser level, turn the locking switch #1 to the **OFF** position, this will lock the pendulum and protect your laser.

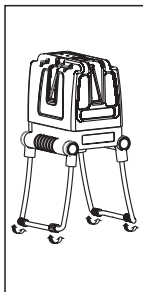
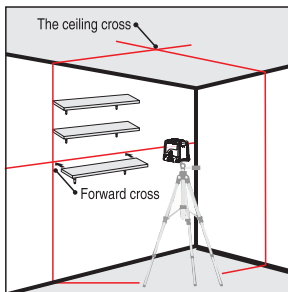

Working in Manual mode:

In Manual mode the 873G's self-leveling mechanism is disabled and the laser lines can be set at any slope required. The laser beams will flash every 3 seconds to let you know that you are working outside the self-leveling range and the beams may not be leveled

1. Press the Manual push button mode . The laser will project the cross lines and the red LED near the push button will light up. The green LED of the laser beams near **V/H** push button will light up.
2. Choose the beams that you want to work with by pushing the Beam Selector push button **V/H**
3. To mark a slope, tilt the laser using the adjustable folding legs to adjust the right angle and the height.
4. To turn the manual mode off, press again the Manual push button .
5. While in Manual mode turning the locking switch #1 from **OFF** to **ON** will turn off the Manual mode and the red LED near the push button. The automatic self – leveling will be activated if the laser level is within the self – leveling range.

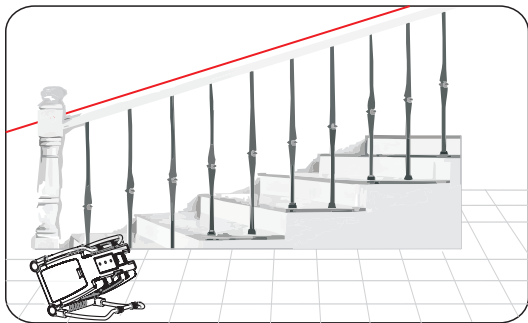

Working in Pulse mode with a detector:

For outdoor work under direct sunlight, or bright conditions and for extended indoor ranges of up to 60 meters/ 200 feet, use the Pulse Mode with a Detector.

When the Pulse Mode is activated the laser beams will flash at a very high frequency (invisible to the human eye) this will allow the detector to locate the laser beams.

1. The Pulse Mode can be activated in Automatic and Manual modes.
2. To switch on the Pulse Mode press the **P** button, the green LED next to it will light up.
3. When the Pulse Mode is switched on, the visibility of the laser beams are reduced a little bit.
4. To switch off the Pulse Mode press the **P** button again and the green LED near it will turn off.

MAINTENANCE

To assure the accuracy of your project, check the accuracy of your laser level according to the field calibration test procedures.

- Change the batteries when the laser beams begin to dim.
- Wipe the aperture lens and the body of the laser level with a clean soft cloth. Do not use solvents.
- Although the laser level is dust and dirt resistant to a certain degree, do not store in dusty places as long term exposure may damage internal moving parts.
- If the laser level is exposed to water, dry the laser level before returning it to the carrying case to prevent corrosion damage.
- Remove the batteries if the laser level is unused for a long period of time to prevent corrosion damage.

This laser level left the factory fully calibrated. Kapro recommends the user check the accuracy of the laser periodically, especially if the unit falls or is mishandled.

1. Check the height accuracy of the horizontal beam.
2. Check the leveling accuracy of the horizontal beam.
3. Check the leveling accuracy of the vertical beam.
4. Check the perpendicularity between the 2 vertical beams.

1. Checking the Height Accuracy of the Horizontal beam. (Up and down deviation)

- 1) Set up the laser on a tripod or on a flat surface between two walls **A** and **B**, approximately 5 meters apart.
- 2) Position the laser level approximately 0.5 meter from wall **A**
- 3) Unlock the pendulum and press the button to project the horizontal and the vertical cross beams towards wall **A**.
- 4) Mark the center of the cross beams on the wall as **a1** (see figure # 1).

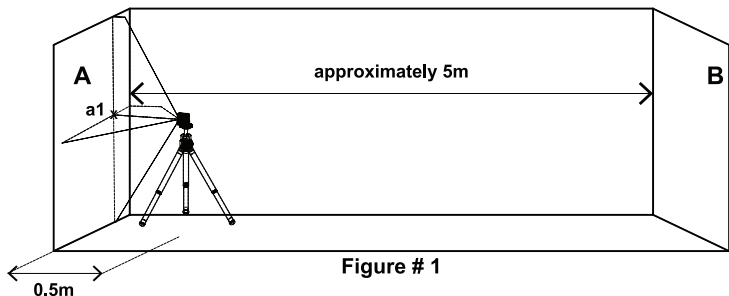

Figure # 1

5) Turn the laser 180° towards wall **B** and mark the center of the cross beams as **b1** on the wall (see figure 2).

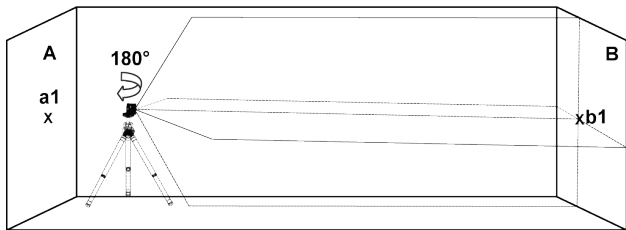

Figure # 2

6) Move the laser level towards wall **B** and position it approximately 0.5 meter from wall **B**.

7) Mark on wall **B** the center of the cross beams as **b2** (see figure 3).

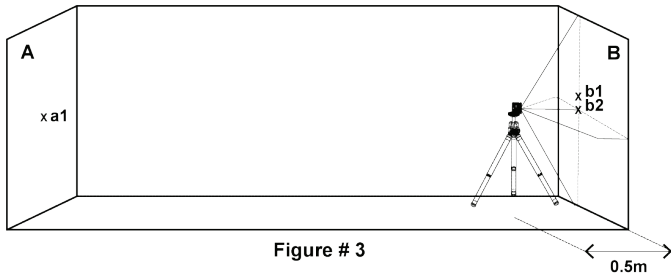

Figure # 3

- 8) Turn the laser 180° towards wall **A**, and mark on the wall the center of the cross beams as **a2** (see figure 4).

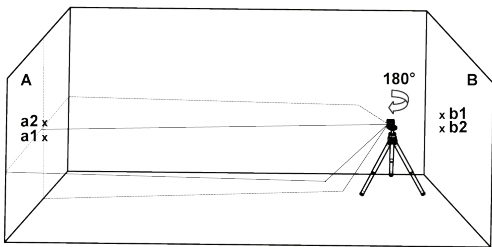

Figure # 4

- 9) Measure the distances:

$$\Delta a = |a2 - a1|$$

$$\Delta b = |b1 - b2|$$

- 10) The difference $|\Delta a - \Delta b|$ should be no more than 2 mm, if otherwise send the laser level to a qualified technician for repair.

2. Checking the Level Accuracy of the Horizontal beam. (Side to side inclination)

- 1) Set up the laser on a tripod or on a flat surface at a distance of approximately 1.5 meters from a 5 meter/16 feet long wall.
- 2) Unlock the pendulum and press the button to project the horizontal and the vertical cross beams towards the wall.

- 3) Mark point **a1** on the wall, in the middle of the horizontal line at the left edge of the horizontal beam (see figure 5).

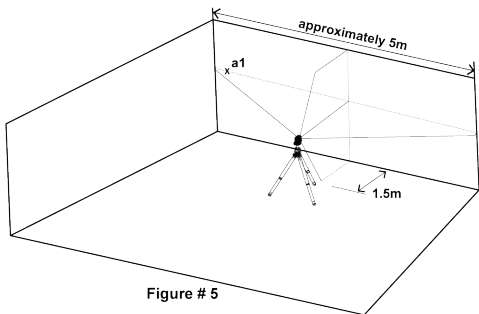

Figure # 5

- 4) Turn the laser level counterclockwise until the right edge of the horizontal beam reaches near **a1**, mark a point **a2** on the wall in the middle of the horizontal beam (see figure 6).

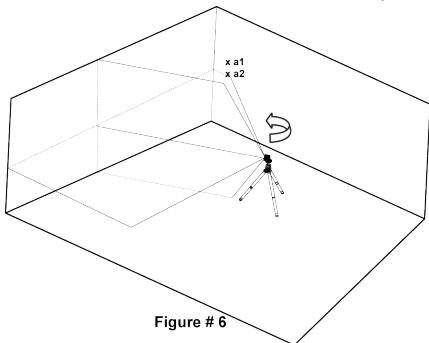
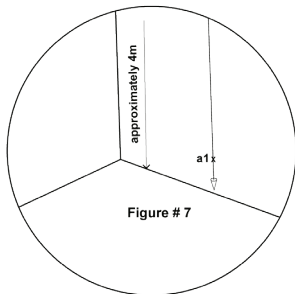

Figure # 6

- 5) The distance between a1 and a2, should be no more than 1 mm, if otherwise send the laser level to a qualified technician for repair.

3. Checking the Accuracy of the Vertical beam.

- 1) Hang an approximately 4 meter /13 feet plumb line on a wall.
- 2) After the plumb line has settled, mark point **a1** on the wall, behind the plumb line, near the plumb cone. (see figure 7).



- 3) Set up the laser on a tripod or on a flat surface in front of the wall at a distance of approximately 2 meter/ 6.5 feet.
- 4) Unlock the pendulum, and press the button to project the vertical beam towards the plumb line.
- 5) Turn the laser so that the vertical beam will merge with the plumb line below the hanging point.

- 6) Mark point **a2** on the wall, in the middle of the vertical beam at the same height as **a1**. (see figure 8).

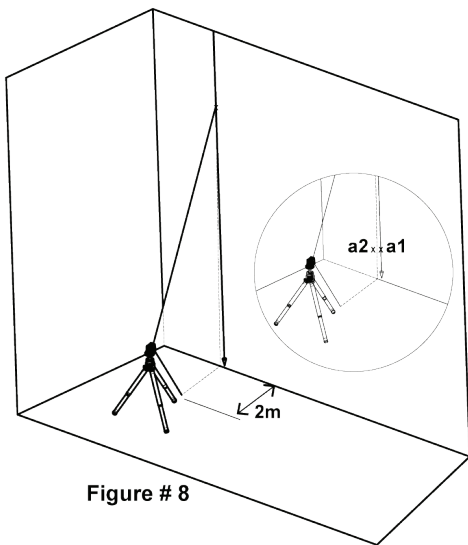

Figure # 8

- 7) The distance between **a1** and **a2**, should be no more than 1mm, if otherwise send the laser level to a qualified technician for repair.

4. Checking 90° accuracy between the 2 vertical beams.

This procedure requires a room of at least 5x5 meters with 4 walls.

- 1) Set up the laser on a table or on the floor in the middle of the room.
- 2) Unlock the pendulum, and press the **V/H** button 4 times to project the forward and the side vertical beams (see figure 9).

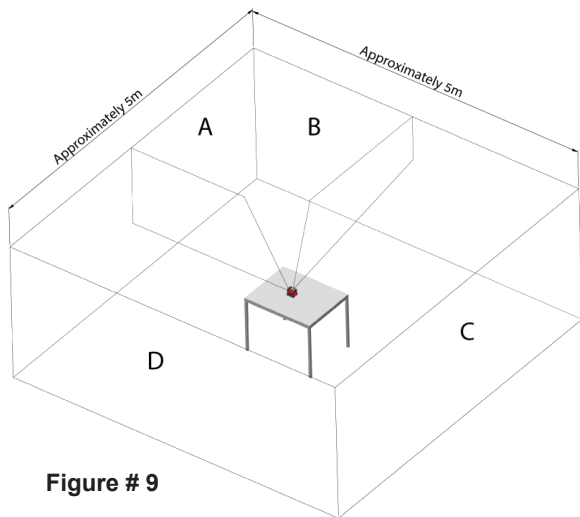
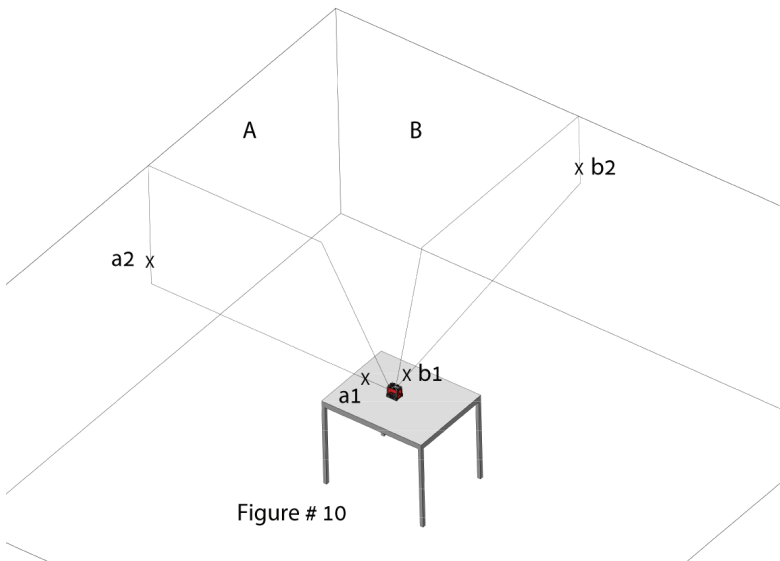
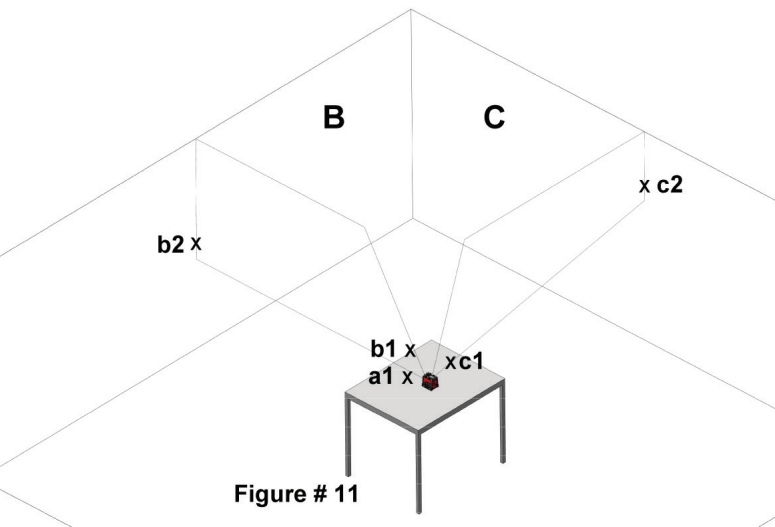

Figure # 9

- 3) Mark the center of the forward vertical beam at 2 locations.
point **a1** on the table near the laser, and point **a2** on wall **A**.
 - 4) Mark the center of the side vertical beam at 2 locations.
point **b1** on the table near the laser, and point **b2** on wall **B**.
- (see figure 10).



- 5) Rotate the laser clockwise so that the forward laser beam passes through marks **b1** on the table, and **b2** on wall **B**.
- 6) Mark the center of the side vertical beam at 2 locations. Point **c1** on the table near the laser, and point **c2** on wall **C**.
(see figure 11).



- 7) Rotate the laser clockwise so that the forward laser beam passes through marks **c1** on the table, and **c2** on wall **C**.
- 8) Mark the center of the side vertical beam at 2 locations. Point **d1** on the table near the laser, and point **d2** on wall **D**.
(see figure 12).

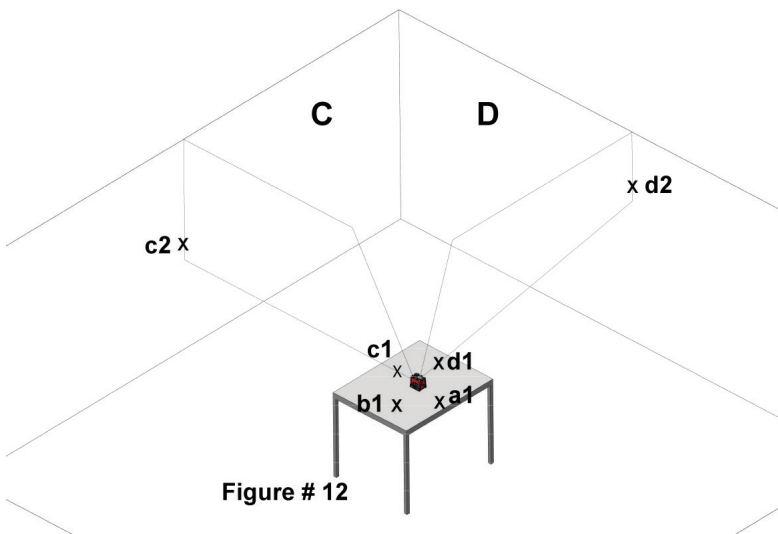

Figure # 12

- 9) Rotate the laser clockwise so that the forward laser beam passes through marks **d1** on the table, and **d2** on wall **D**.
- 10) Mark the center of the side vertical beam at 2 locations. Point **a3** on the table near point **a1**, and point **a4** on wall **A** near point **a2**. (see figure 13).

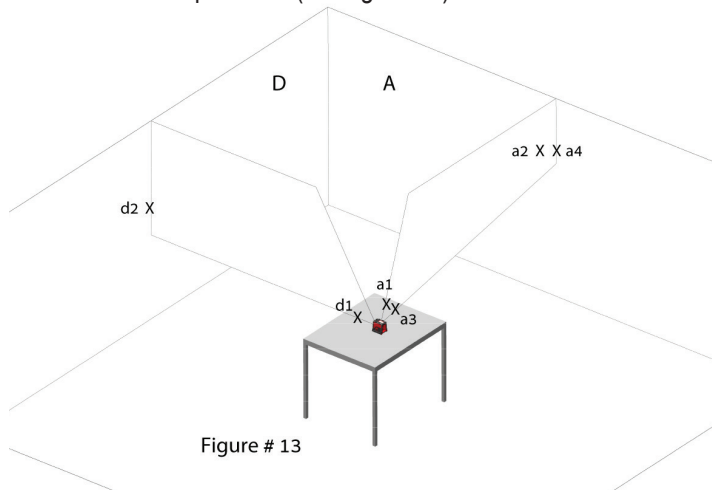

Figure # 13

- 11) Measure the distances:

$\Delta 1 =$ from **a1** to **a3**

$\Delta 2 =$ from **a2** to **a4**

- 12) The difference $\Delta 2 - \Delta 1$ should be no more than 3 mm, if otherwise send the laser level to a qualified technician for repair.

SPECIFICATIONS

Laser beams output pattern	Horizontal and 2 orthogonal vertical beams Horizontal and forward vertical cross beams Horizontal beam Forward vertical beam Forward and side orthogonal vertical beams
Laser range	<ul style="list-style-type: none">• Indoor - 30m (100ft)• Outdoor with detector 60m (200ft)
Accuracy	$\pm 0.2\text{mm/m}$ ($\pm 0.0002\text{in/in}$)
Fan angle	$120^\circ \pm 5^\circ$
Self-leveling Range	$\pm 3^\circ$
Laser line width	2mm $\pm 0.5\text{mm}/5\text{m}$ (0.10" ± 0.02 " at 20')
Wavelength	520 $\pm 10\text{nm}$ Laser Class II
Power supply	3 AA batteries (included)
Battery life	6 hours of continuous operation
Operating temp	-10° C +45° C (14°F - 113°F)
Storage temp	-20° C +60° C (-4°F - 140°F)
Water & dust proof	IP54
Dimensions	10.6cm x 8.8cm x 10.5cm (4.1" x 3.4" x 4.0")
Weight including batteries	710gr $\pm 10\text{gr}$ (1.56lbs $\pm 0.3\text{oz}$)



WARRANTY

This product is covered by a two-year limited warranty against defects in materials and workmanship. The warranty does not cover products that are used improperly, altered or repaired without Kapro Tool's approval. In the event of a problem with the laser level, please return the product to the place of purchase with proof of purchase.

Model #873G Prolaser® Vector

The serial number sticker is positioned inside the battery compartment.

CE CONFORMITY CERTIFICATE

This product meets the standards of the Electromagnetic Compatibility (EMC) established by the European Directive 2014/30/EU and the Low Voltage Directive (LVD) 2014/35/EU

EC DECLARATION OF CONFORMITY

We declare under our responsibility that the product 873G is in accordance with the requirements of the Community Directives and Regulations:

2014/30/EU

2011/65/EU

EN60825-1: 2014

EN61326-1: 2013

