



Prolaser® Bambino GREEN

Model No. 842G

User Manual





Thank you for purchasing Kapro's 842G Prolaser® Bambino GREEN.

You now own one of the most advanced laser tools available. This manual will show you how to get the most out of your laser tool.

APPLICATIONS

The 842G Prolaser® Bambino GREEN is a laser level with one green diode. The laser is innovatively designed for a very broad range of professional and DIY jobs, including:

- Aligning tiles, marble, cabinets, borders, moldings and trimmings
- Marking lay out for doors, windows, rails, stairs, fences gates, decks and pergolas installation.
- All types of DIY jobs, including hanging shelves, hanging hooks, pictures, curtains and more

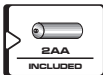
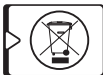
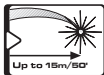

NOTE

Keep this user manual for future reference.

CONTENTS

• Features	4
• Safety instructions	5-6
• Battery installation & Safety	7-8
• Overview	9
• Operating instructions	10-11
• Maintenance	12
• Field calibration test	13-18
• Specifications	19
• Warranty	20-21



FEATURES

- This laser tool automatically determines the horizontal and vertical plans.
- The laser projects intersected horizontal and vertical lines.
- Max. indoor working range - 15 m (50').
- Self-levels in automatic mode when the laser is positioned within its self-leveling range.
- Visual warning (blinking) when the laser is out of leveling range falls.
- Manual mode allows angular layout/marketing.
- Locking mechanism to protect the pendulum during transportation.
- 1/4" tripod adaptor.
- Compact size - fits in your toolbox.

NOTE

This device contains precision components that are sensitive to external shock, impact or drop that may compromise its functionality –handle with care to maintain its accuracy.

SAFETY INSTRUCTIONS



WARNING

This product is emitting radiation that is classified As class II according to EN 60825 -1

The laser radiation can cause serious eye injury



- Do not stare into the laser beam
- Do not position the laser beam so that it unintentionally blinds you or others.
- Do not operate the laser level near children or let children operate the laser level.
- Do not look into a laser beam using magnifying optical devices such as binoculars or a telescope, as this will increase the level of eye injury.

WARNING: This product contains lead in solder and certain Electrical parts contain chemicals which are known to the State of California to cause cancer, birth defects or other Reproductive harm.

(California Health & Safety Code Section 25249.6- Proposition 65)



NOTE

The green goggles are intended to enhance the visibility of the laser beam. They will not protect your eyes against laser radiation.



- Do not remove or deface warning labels on the laser level.
- Do not disassemble the laser level, laser radiation can cause serious eye injury.
- Do not drop the laser.
- Do not use solvents to clean the laser.
- Do not use in temperatures below -10°C or above 45°C (14°F / 113°F)
- Do not operate the laser in explosive atmospheres such as flammable liquids, gases or dust. Sparks from the tool can cause ignition.
- When not in use, turn off the power, engage the pendulum lock and place the laser in the carrying pouch.
- Make sure the pendulum lock mechanism is engaged before transporting the laser.

NOTE

If the pendulum lock mechanism is not engaged before transportation, internal mechanical damage may occur.

BATTERY INSTALLATION & SAFETY

1. Push the latch and open the battery cover.
2. Insert 2 new AA batteries of the same brand according to the polarity diagram on the inside of the battery compartment.
3. Close the battery cover.

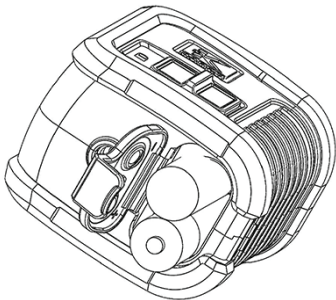

NOTE

If the laser level will not be used for a long period of time, remove the batteries from the battery compartment. This will battery leakage and corrosion damage.



WARNING: Batteries can deteriorate, leak or explode, and can cause injury or fire.

1. Do not shorten the battery terminals.
2. Do not charge Alkaline batteries.
3. Do not mix old and new batteries.
4. Do not through batteries into household waste.
5. Do not dispose of the batteries in fire.
6. Defective or dead batteries must be disposed of according to local regulations.
7. Keep the batteries out of reach from children.

OVERVIEW

1. On/Off Locking Switch
2. Laser output window
3. Manual Mode button
4. Operation LED indicator
5. Battery cover
6. 1/4" Tripod mount

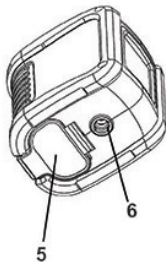





OPERATING INSTRUCTIONS

Working in Automatic Mode (self-leveling):

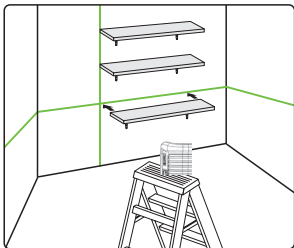

In automatic mode the laser level will level itself in the range of $\pm 3^\circ$ and will project crossed horizontal and vertical laser beams.

1. Remove the laser from the pouch and place it on a solid, flat, vibration free surface or on a tripod
2. Push the locking switch #1 to the  position.
The laser level will generate the crossed horizontal and vertical lines and the green LED will light up.
3. If the initial slope of the laser is beyond $\pm 3^\circ$ the laser lines will flash. In this case reposition the laser on a more leveled surface.
4. Before moving the laser level switch the locking switch #1 back to the  position, this will lock the pendulum and protect your laser.



Working in Manual Mode:

In manual mode the self-leveling mechanism of the 842G is disabled (button #1 is in OFF position) and the laser lines can be set at any slope required.

1. To activate the Manual mode, long press the #3 button. The laser will project blinking cross lines and the red LED will light up.
2. Tilt the laser to the desired slope.
3. To turn the manual mode off, press the Manual mode button again.
4. While in Manual mode turning the locking switch #1 from  to  position will turn off the Manual mode. The automatic self – leveling will be activated if the laser level is within the self – leveling range.



MAINTENANCE

- To maintain the accuracy of your project, check the accuracy of your laser level according to the field calibration tests procedures.
- Change the batteries when the laser beams begin to dim.
- Wipe the aperture lens and the body of the laser level with a clean soft cloth. Do not use solvents.
- Although the laser level is dust and dirt resistant to a certain degree, do not store in dusty places as long term exposure may damage internal moving parts.
- If the laser level is exposed to water, dry the laser level before returning it to the carrying case to prevent corrosion damages.
- Remove the batteries if the laser level is unused for for an extended period, to prevent corrosion damage.

FIELD CALIBRATION TEST

This laser level left the factory fully calibrated. Kapro recommends checking the accuracy of the laser periodically, or if the unit falls or is mishandled.

To do so, first check the height accuracy of the horizontal line, then check the leveling accuracy of the horizontal line, and finally check the leveling accuracy of the vertical line.

Checking the Height Accuracy of the Horizontal Line. (Up and down deviation)

- 1) Set up the laser on a tripod or on a flat surface between two walls **A** and **B**, approximately 5 meters apart.
- 2) Position the laser level approximately 0.5 meter from wall **A**
- 3) Unlock the pendulum and press the button to project the horizontal and the vertical cross lines towards wall **A**.
- 4) Mark the center of the cross lines as **a1** on the wall.
(see figure 1)

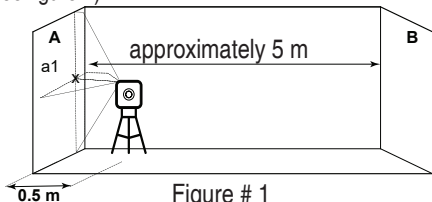

Figure # 1

- 5) Turn the laser 180° towards wall **B**, and mark the center of the cross lines as **b1** on the wall (see figure 2).

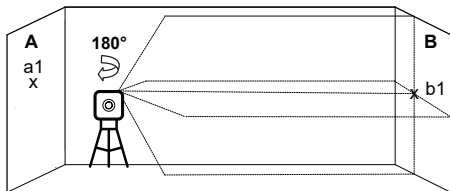

Figure # 2

- 6) Move the laser level towards wall **B** and position it approximately 0.5 meters from wall **B**.
- 7) On wall **B** mark the center of the cross lines as **b2** (see figure 3).

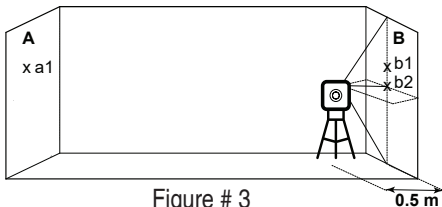

Figure # 3

- 8) Turn the laser 180° towards wall **A**, and mark the center of the cross lines as **a2** on the wall (see figure 4).

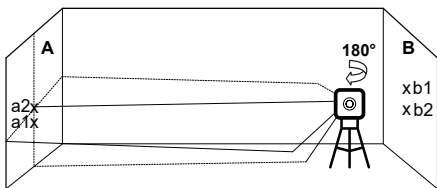

Figure # 4

- 9) Measure the distances:

$$\Delta a = |a2 - a1|$$

$$\Delta b = |b1 - b2|$$

- 10) The difference $|\Delta a - \Delta b|$ should be no more than 4 mm, otherwise send the laser level to a qualified technician for repair.

Checking the Level Accuracy of the Horizontal Line. (Side to side inclination)

- 1) Set up the laser on a tripod or on a flat surface at a distance of approximately 1.5 meters from a 5 meter long wall.
- 2) Unlock the pendulum and press the button to project the horizontal and the vertical cross lines towards the wall.

- 3) Mark point **a1** on the wall, in the middle of the horizontal line at the left edge of the horizontal line (see figure 5).

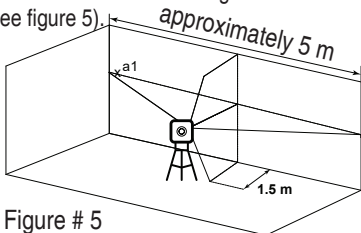

Figure # 5

- 4) Turn the laser level counterclockwise until the right edge of the horizontal line reaches near **a1**, mark a point **a2** on the wall, in the middle of the horizontal line (see figure 6).

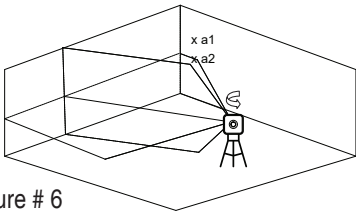
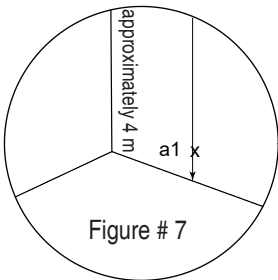

Figure # 6

- 5) The distance between **a1** and **a2**, should be no more than 2 mm otherwise send the laser level to a qualified technician for repair.

Checking the Accuracy of the Vertical line.

- 1) Hang an approximately 4 meter plumb line on a wall.
- 2) After the plumb line has settled, mark point **a1** on the wall, behind the plumb line near the plumb cone. (see figure 7).



- 3) Set up the laser on a tripod or on a flat surface in front of the wall, at a distance of approximately 2 meters.
- 4) Unlock the pendulum and press the button to project the vertical line toward the plumb line.
- 5) Turn the laser so that the vertical line will merge with the plumb line below the hanging point.

- 6) Mark point **a2** on the wall, in the middle of the vertical line at the same height as **a1**. (see figure 8).

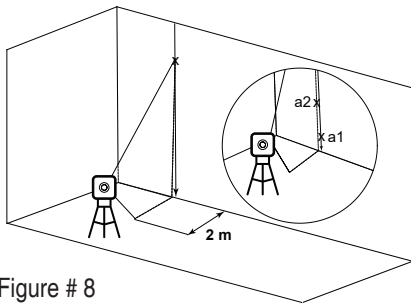

Figure # 8

- 7) The distance between **a1** and **a2**, should be no more than 2mm, otherwise send the laser level to a qualified technician for repair.

SPECIFICATIONS

Laser beams output pattern	Vertical and horizontal cross lines
Laser range	Indoor - 15m (50ft)
Accuracy	$\pm 0.4\text{mm/m}$ ($\pm 0.0004\text{in/in}$)
Fan angle	$100^\circ \pm 5^\circ$
Self-leveling range	$\pm 3^\circ$
Laser line width	$2.5\text{ mm} \pm 0.5\text{mm}/5\text{m}$ ($0.13'' \pm 0.02''$ at 20')
Wavelength	$520 \pm 10\text{nm}$ - Laser Class II
Power supply	2 AA batteries (included)
Battery life	12 hours of continuous operation
Operating temp.	$-10^\circ\text{ C} + 45^\circ\text{ C}$ ($14^\circ\text{F} + 113^\circ\text{F}$)
Storage temp.	$-20^\circ\text{ C} + 60^\circ\text{ C}$ ($-4^\circ\text{F} + 140^\circ\text{F}$)
Water & dust proof	IP54
Dimensions	$7.6\text{cm} \times 6.5\text{cm} \times 5\text{cm}$ ($3'' \times 2.6'' \times 2''$)
Weight including batteries	$180\text{gr} \pm 10\text{gr}$ ($0.4\text{ lbs} \pm 0.35\text{ oz}$)



WARRANTY

This product is covered by a two year limited warranty against defects in materials and workmanship. The warranty does not cover products that are used improperly, altered, or repaired without Kapro's approval, nor a process of recalibration if needed.

REPAIR AND CALIBRATION PROCEDURE

1. If your product requires repair or calibration, please return it to the point of sale, alongside your proof of purchase.
2. After a return authorization procedure is initiated, the laser level will be sent to an authorized repair lab.
3. Once completed, the product will be returned to a point of sale of your choice for collection.

COSTS AND WARRANTY

- Products under warranty will be shipped and repaired free of charge.
- In case of products that are not under warranty, you will be notified by the dealer of the estimated cost for the repair, before the beginning of the process.

The serial number sticker is positioned inside the battery compartment.

CE CONFORMITY CERTIFICATE

This product meets the standards of the Electromagnetic Compatibility (EMC) established by the European Directive 2014/30/EU and the Low Voltage Directive (LVD) 2014/35/EU

EC DECLARATION OF CONFORMITY

We declare under our responsibility that the product 842G is in accordance with the requirements of the Community Directives and Regulations:

2014/30/EU

2011/65/EU

EN60825-1: 2014

EN61326-1: 2013



Rev. 2.0

© 2023 Kapro Industries Ltd.